

LANKELEISI

E-BIKE USER MANUAL



ATTENTION

Please read this manual carefully before using the lankeleisi electric bicycle. If you do not understand this information, or if you do not cover the issues covered in this manual, please contact the dealer.



WELCOME TO LANKELEISI

THANK YOU FOR CHOOSING LANKELEISI E-BIKES

Welcome to your new lankeleisi E-Bike! You are entering a new world of ease, luxury, and mobility. Whether you're looking for an environmentally friendly alternative to your regular gas-powered vehicle, a fun way to avoid traffic congestion, or simply want to spend more time outdoors, we hope you enjoy your new E-Bike. In a life full of headwinds and tailwinds, it is our honor to be the wind at your back.

If you have questions or comments, please don't hesitate to contact us:

Email: ming@lklsebike.com

web: lklsebike.com

VEHICLE IDENTIFICATION NUMBER / SERIAL NUMBER

FOR YOUR RECORDS

For future reference, please fill in the important information below. Your serial number can be found on the inward-facing surface of the frame seat stay or on head top tube.

Please retain your sales receipt for any possible warranty or loss claims.

MY LANKELEISI SERIAL NUMBER:



FOR YOUR RECORDS

MY LANKELEISI E-BIKE

Name

Address

Purchase Date

Purchase Channel

LANKELEISI WEBSITE AMAZON EBAY OTHER

Model

Color

Serial #

LANKELEISI E-BIKES

TABLE OF CONTENTS

ABOUT THIS MANUAL	05
IMPORTANT SAFETY INFORMATION	06
OPERATIONAL INSTRUCTIONS	09
ASSEMBLY INSTRUCTIONS	13
RECHARGING THE BATTERY	19
BATTERY AND CHARGER CARE	21
GEARS	22
LED DISPLAY & KEYS	23
BRAKES	24
TIRES & INNER TUBES	25
TROUBLESHOOTING	26
LANKELEISI E-BIKES FAQs	27
INSPECTION AND MAINTENANCE	29
WARRANTY	31

01 ABOUT THIS MANUAL

This manual was written to help you get the most performance, comfort, enjoyment, and safety when riding your new lankeleisi E-Bike. The manual describes specific care and maintenance procedures that help protect your warranty and ensure years of trouble-free use. Please pay particular attention to the section on battery charging and maintenance.

It is important for you to understand your new lankeleisi

E-Bike, its features, and its operation, so you get maximum enjoyment with maximum safety. By reading this manual before you go out on your first ride, you'll know how to get the most from your new lankeleisi E-Bike.

It is also important that your first ride on a new lankeleisi E-Bike is taken in a controlled environment, away from cars, obstacles, and other cyclists.

02 IMPORTANT SAFETY INFORMATION

Cycling can be a hazardous activity even under the best of circumstances. Proper maintenance of your lankeleisi E-Bike is your responsibility, as it helps reduce the risk of injury. This manual contains many warnings about the consequences of failure to maintain or inspect your

lankeleisi E-Bike. Improper use could result in serious injury or death.

We recommend you use a trusted professional bike technician to assemble your lankeleisi E-Bike.

IMPORTANT SAFETY INFORMATION

A. ALWAYS WEAR A HELMET

Helmets significantly reduce the number and severity of head injuries. Always wear a helmet that complies with your state laws when riding your lankeleisi E-Bike. Check with your local police department for requirements in your community. Make yourself more visible by wearing bright reflective clothing. Keep your reflectors clean and properly aligned. Use head and tail lights in reduced lighting conditions. Wear sturdy shoes and eye protection. Also check your state laws concerning other protective gear that may be required when riding your lankeleisi E-Bike.

B. KNOW YOUR LANKELEISI E-BIKE

Your new lankeleisi E-Bike incorporates many features and functions that you may be unfamiliar with. Read this manual thoroughly to understand how those features enhance your riding pleasure and safety.

C. RIDE WITHIN YOUR LIMITS

Take it slow until you are familiar with the riding conditions, as traction can be greatly reduced and brakes become less effective. Never ride faster than conditions warrant or beyond your riding abilities. Remember that alcohol, drugs, fatigue, and inattention can significantly reduce your ability to make good judgments and ride safely.

D. KEEP YOUR E-BIKE IN SAFE CONDITION

For your safety and enjoyment, and to ensure a long life for your lankeleisi E-Bike, inspect and maintain your E-Bike regularly. Follow the inspection and maintenance guidelines throughout this manual. Check critical safety equipment before each and every ride.

COMPONENT OR CONDITION	INSPECT BEFORE EVERY RIDE	INSPECT PERIODICALLY*	CLEAN AND/OR LUBRICATE	ADJUST/TIGHTEN	REPAIR/REPLACE IF NECESSARY
Tire pressure (55-65 psi)	X			X	
Tire wear/damage	X			X	
Brake pad adjustment	X			X	
Wheel quick release adjustment	X				X
Head and tail lights	X				X
Controls and displays	X				
Seat post quick release adjustment	X			X	
Brake pad wear		X			X
Brake cable tension/wear		X		X	X
Spoke tension		X		X	
Wheel true		X		X	
Hub bearings		X	X	X	
Chain lubrication		X	X		
Derailleur adjustment		X	X	X	
Reflectors		X			X
Battery and charger		X			X
Headset adjustment		X	X	X	
Bottom bracket adjustment		X	X	X	
All bolts, nuts & mounting hardware		X		X	X

*Every 5 to 10 rides depending on length and conditions of ride.

03 ASSEMBLY INSTRUCTIONS



PART 1: REMOVE PACKAGING

Prompt:

Please read the installation steps before installation,
and install according to the installation pictures and
texts



01

Gather necessary tools. Bring your own scissors



02

Unpack the LANKELEISI electric bicycle, take out the electric bicycle and accessories

PART 2: LUGGAGE RACK & HANDLEBAR MOUNTING



01

Remove the fixing screws on both sides



02

Select the angle of the luggage rack to a fixed position

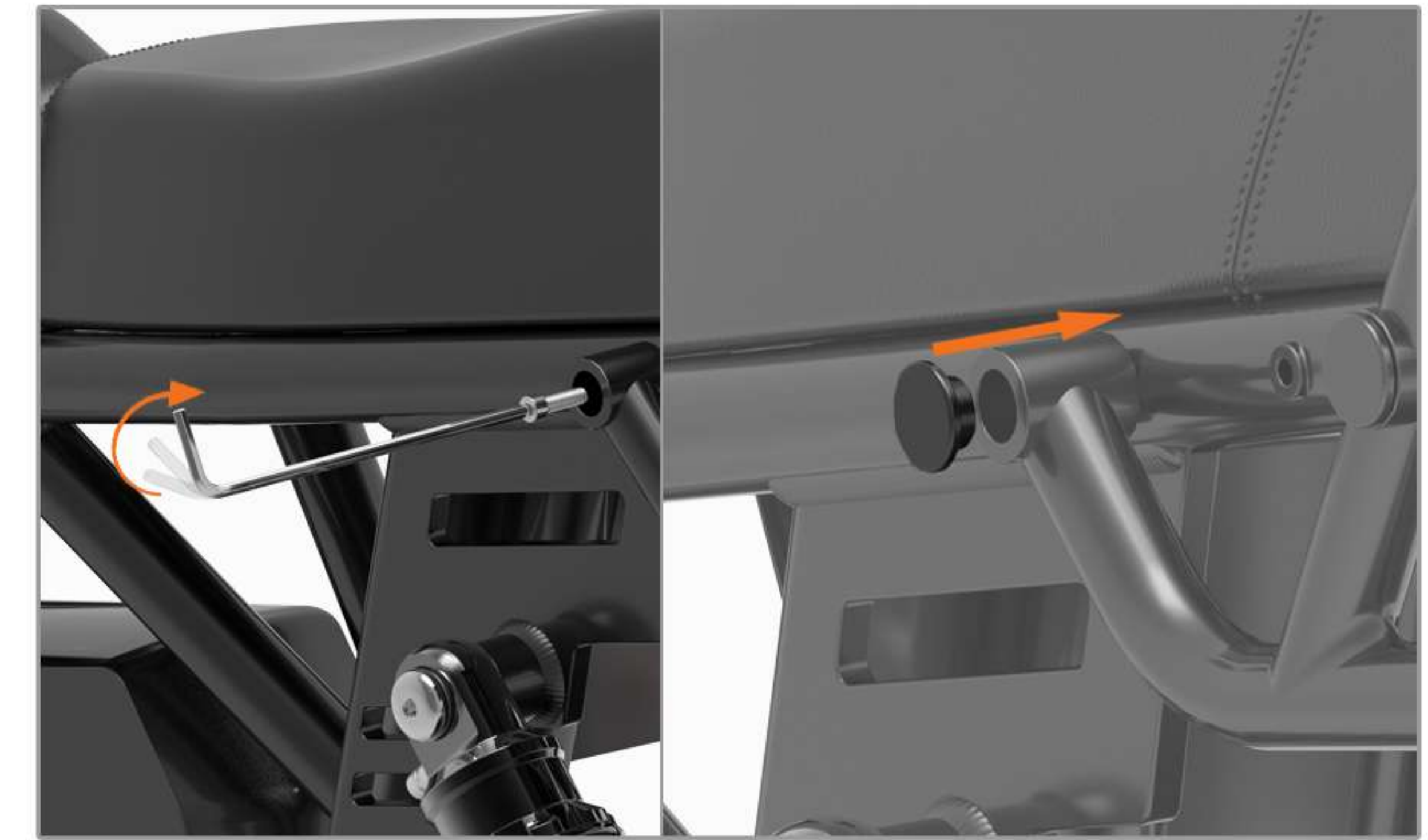

03

Tighten the luggage rack fixing screws, Put the black cover on



04

Install the headlight, tighten the headlight fixing screw

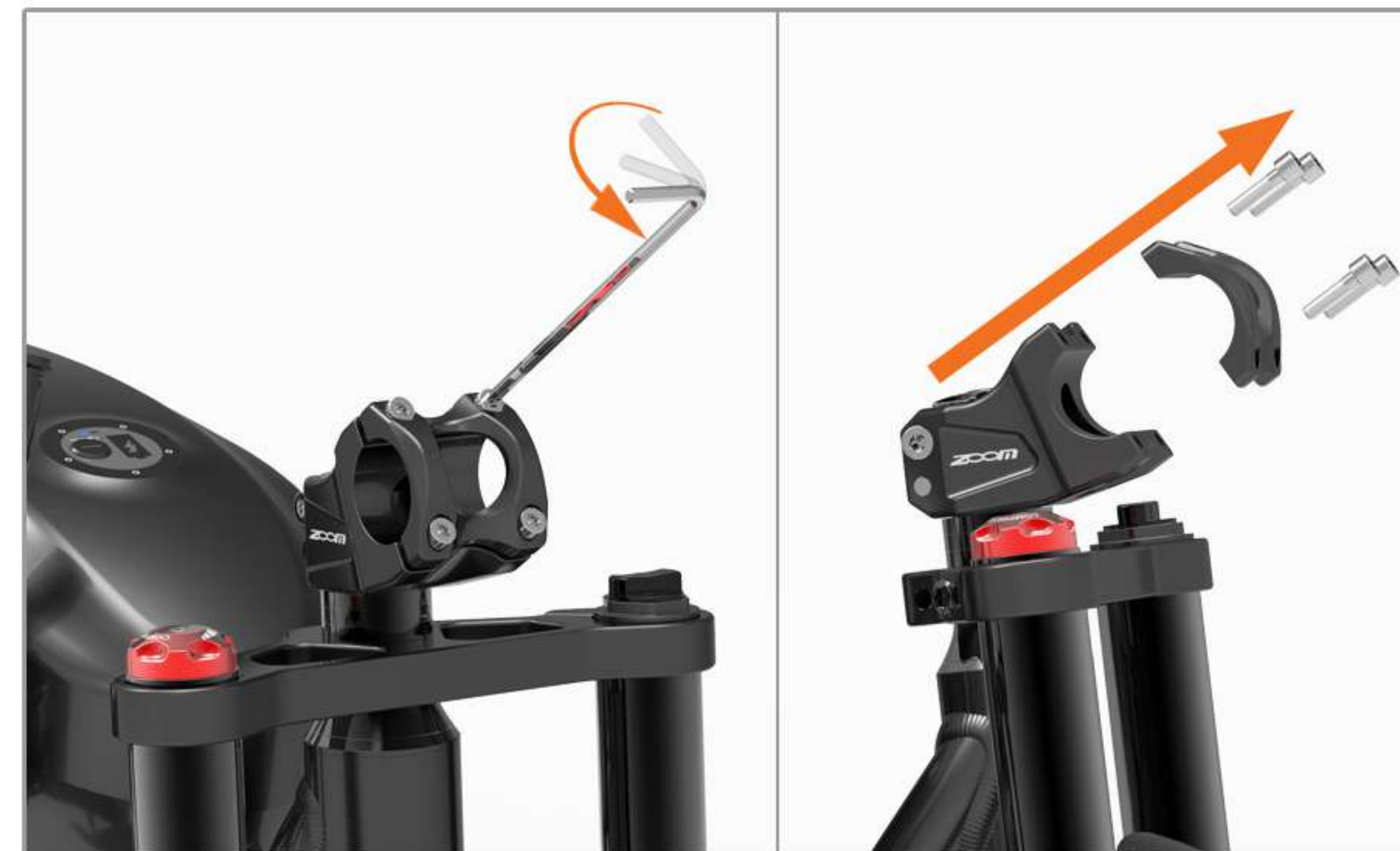

05

Remove front 4 bolts from stem cover, then remove stem cover.

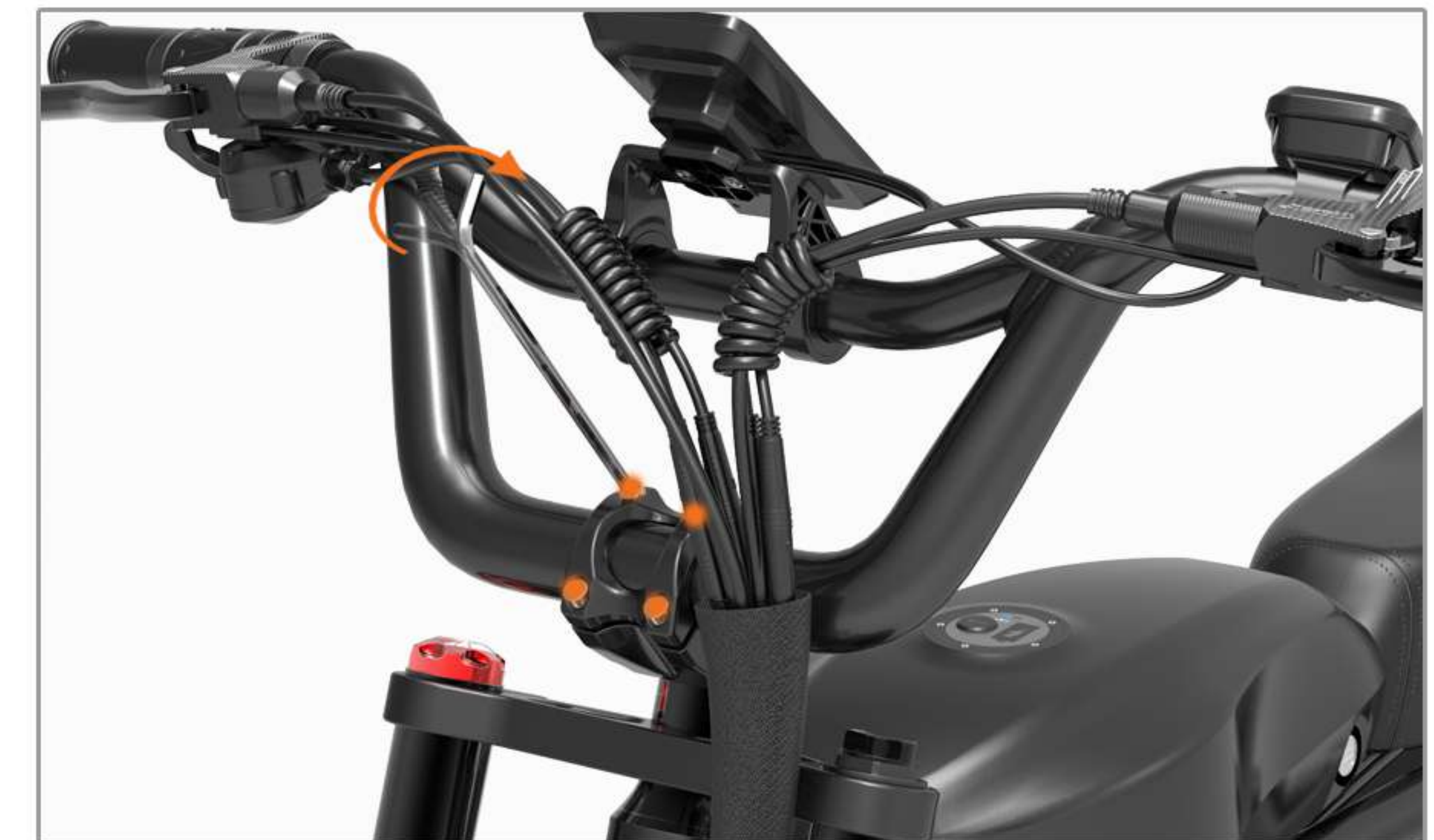

06

Mount handlebar onto stem, then replace stem cover and tighten all 4 bolts. Complete handlebar installation

PART 3: HEADLIGHT & FRONT WHEEL ASSEMBLY

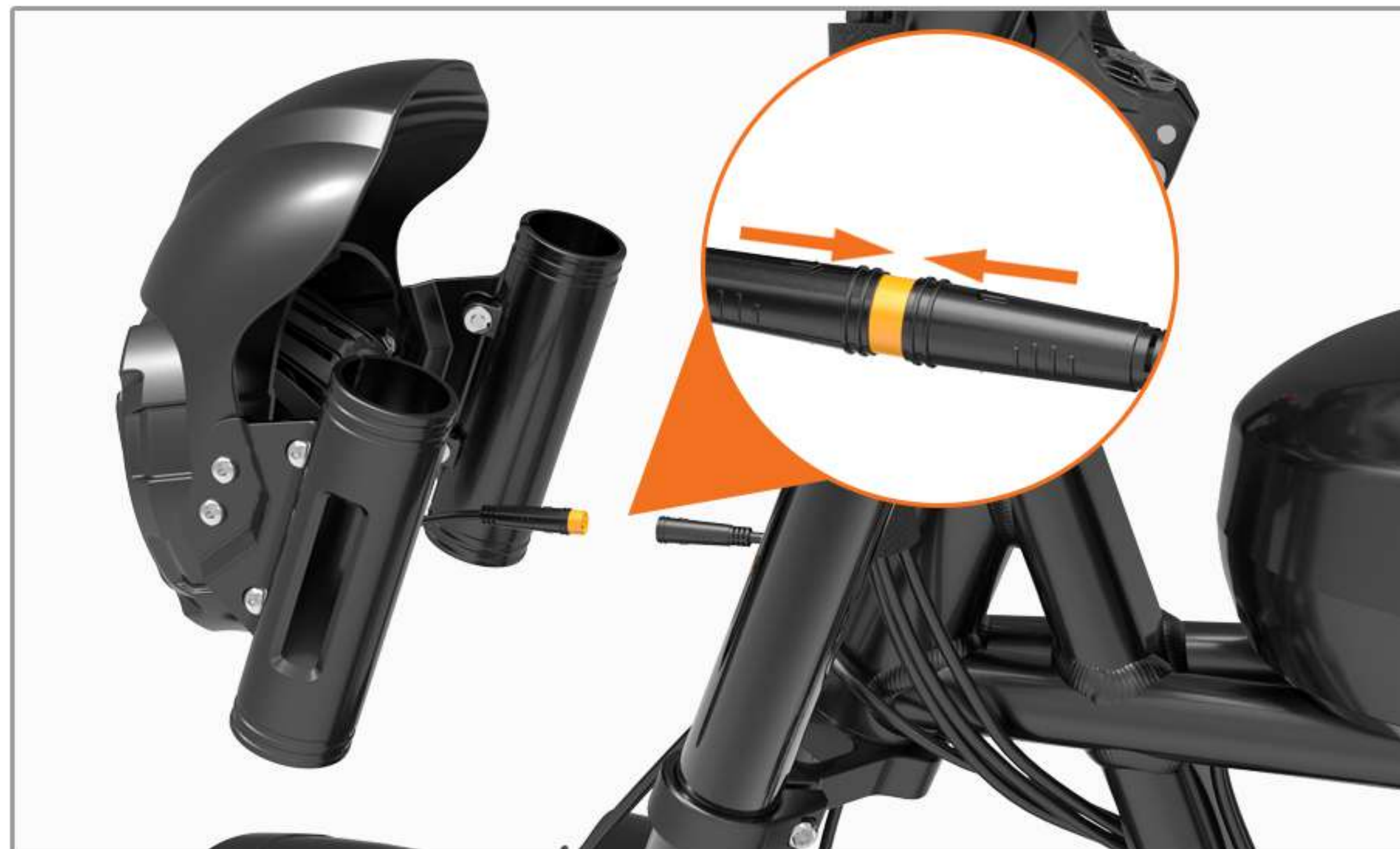

01

Link the headlights, when wiring, the arrows are linked with the arrows

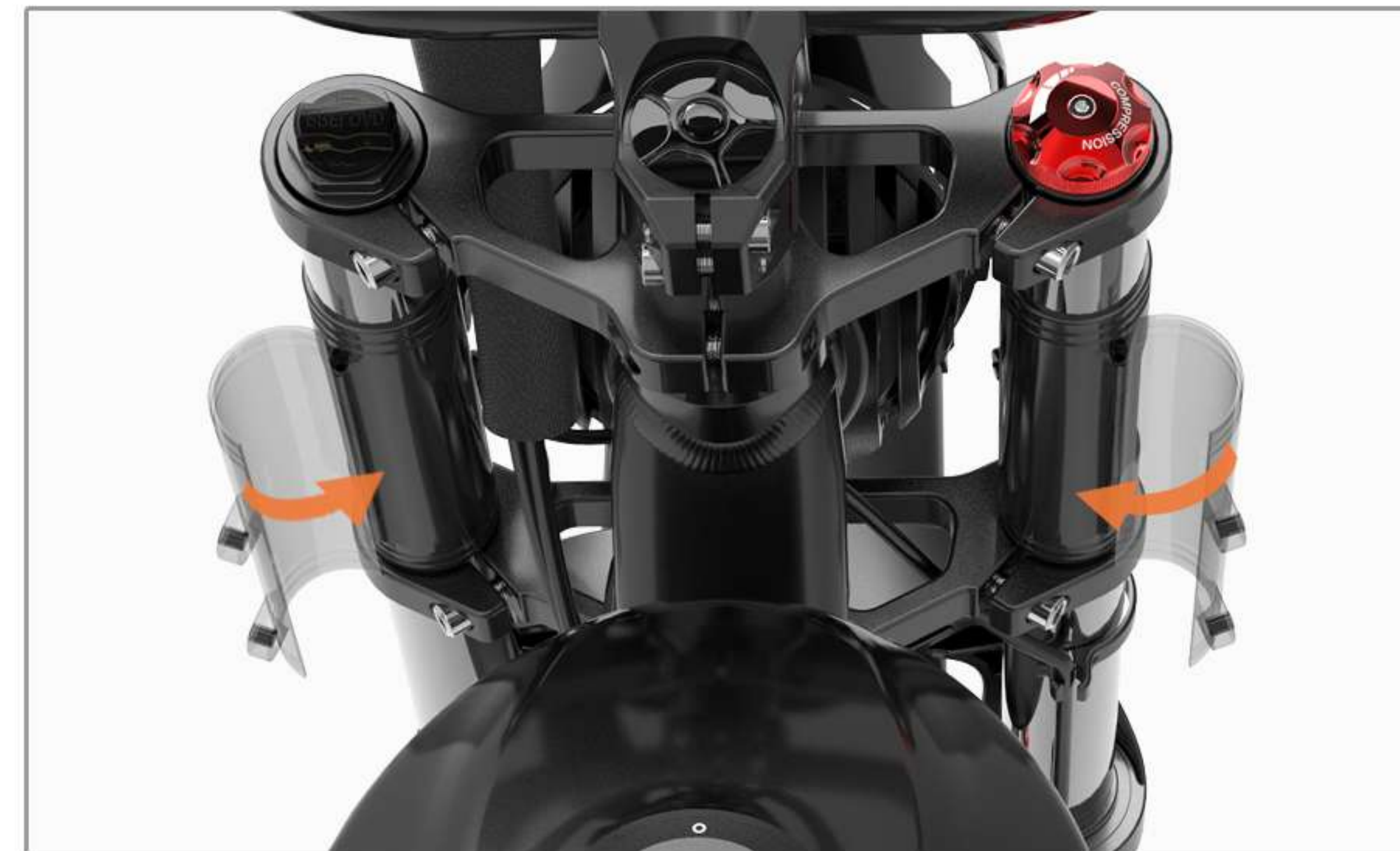

02

Attach the headlight to the fork

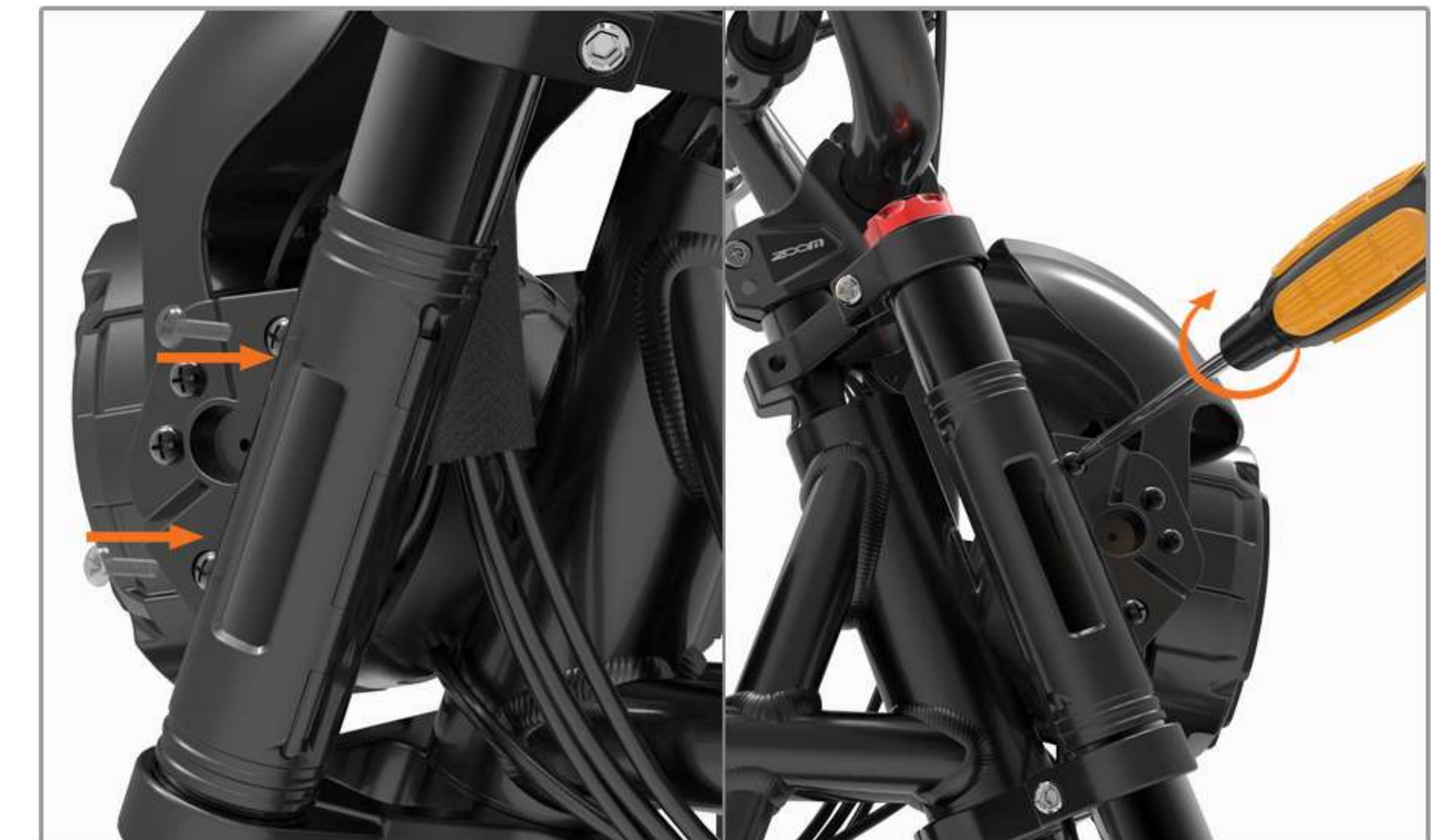

03

Insert the screws on both sides and lock them with the tool, Headlight installation completed.

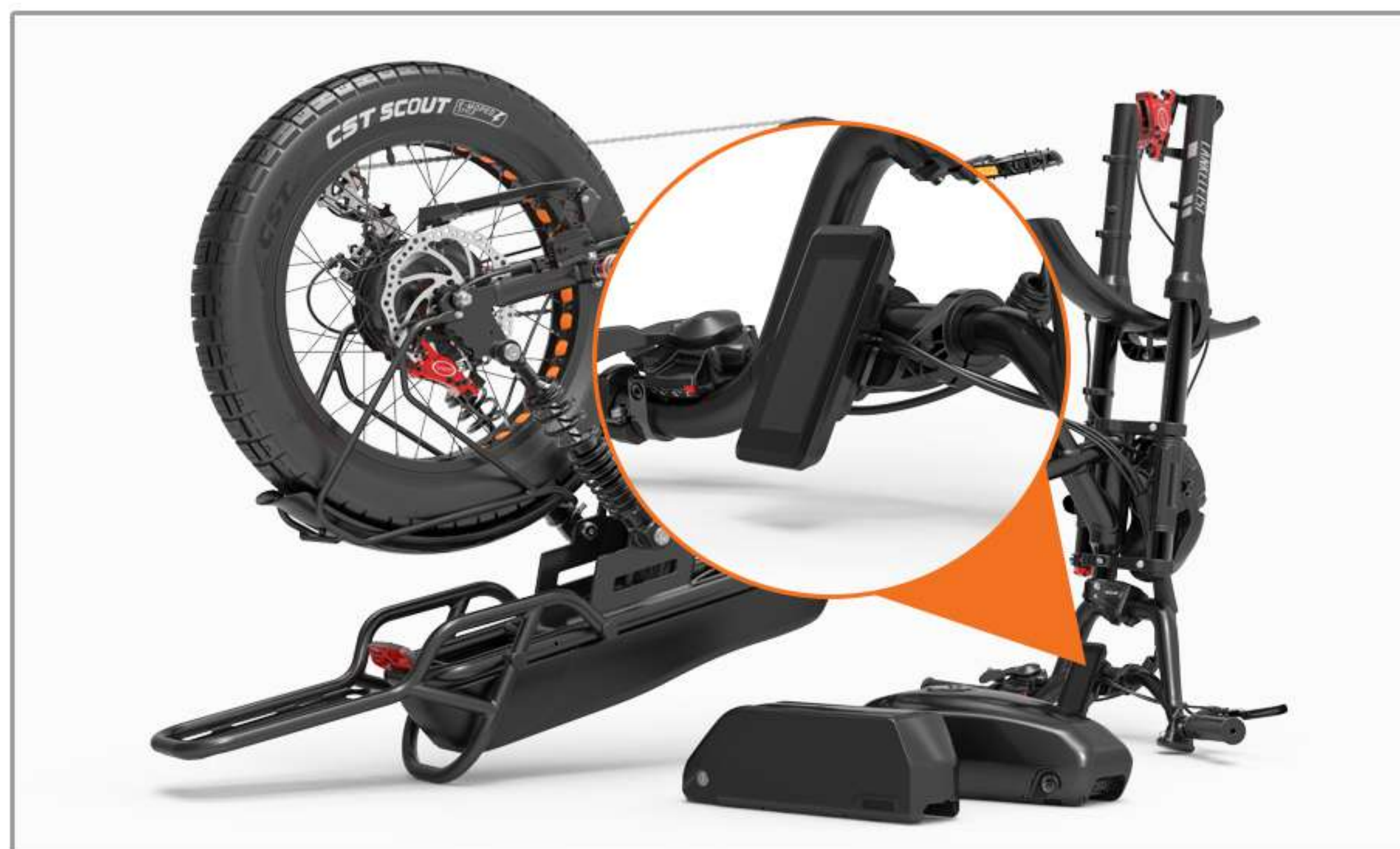

04

Turn the bike upside down.
Flip the instrument angle to avoid direct contact with the ground

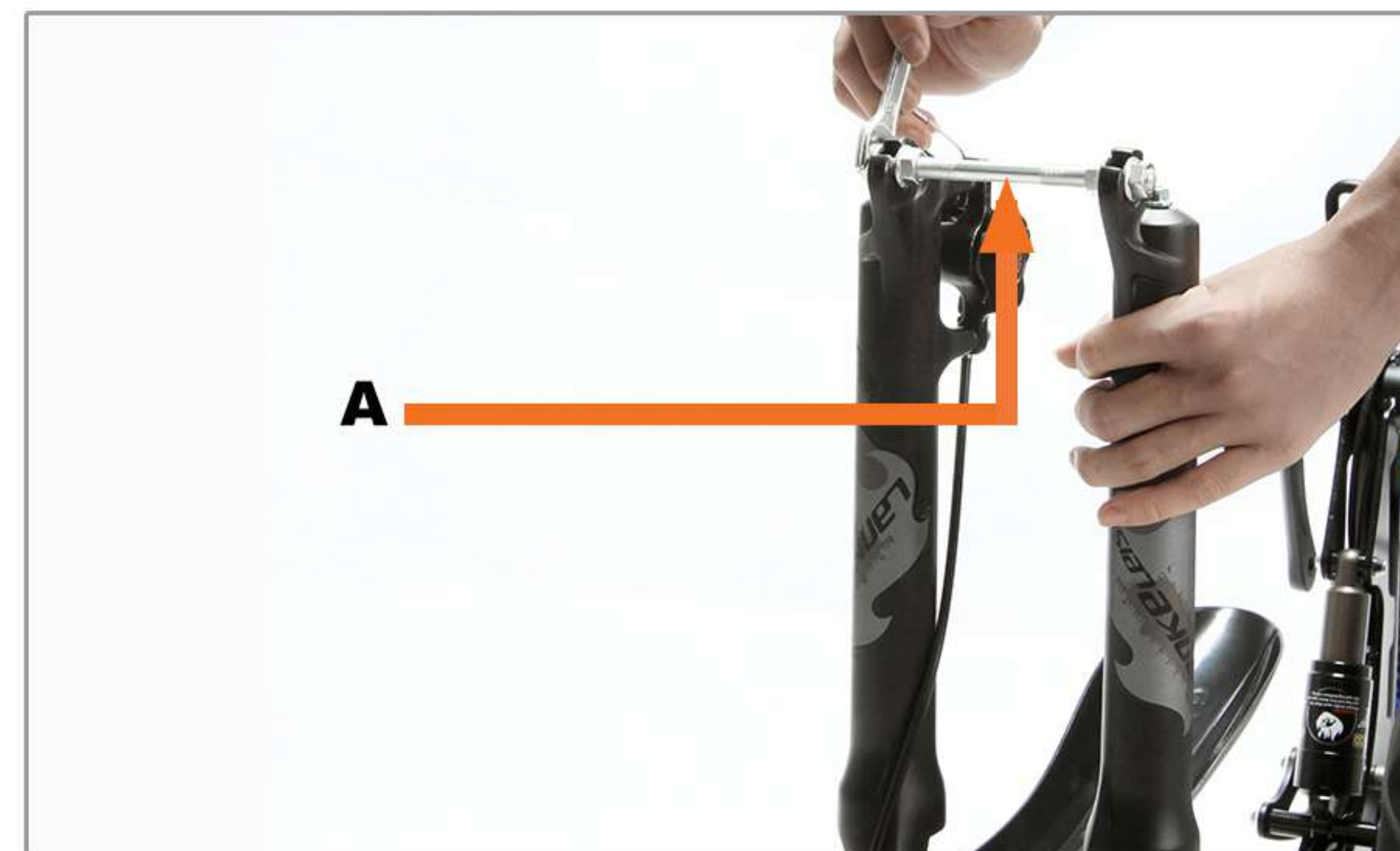

05

Remove the fork protector.
A: The protective shaft can be removed and thrown away



06

Put the wheel in the front fork
Note that the gap between the disc and the caliper is centered

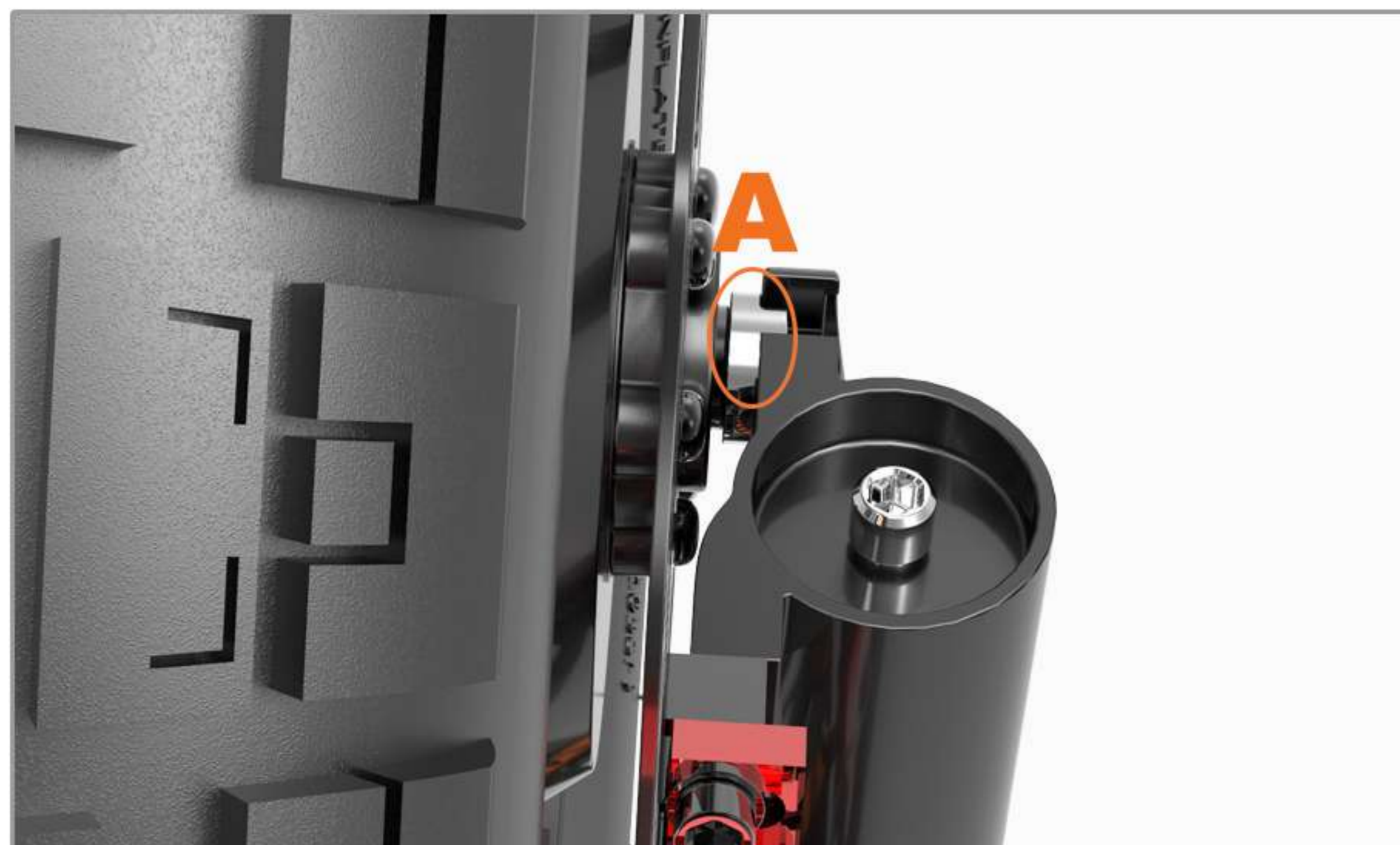

07

Disc brake disc alignment clamp card slot
A: Insert the screw clip into the slot



08

Install the screws and washers



09

Tighten the screw with the tool

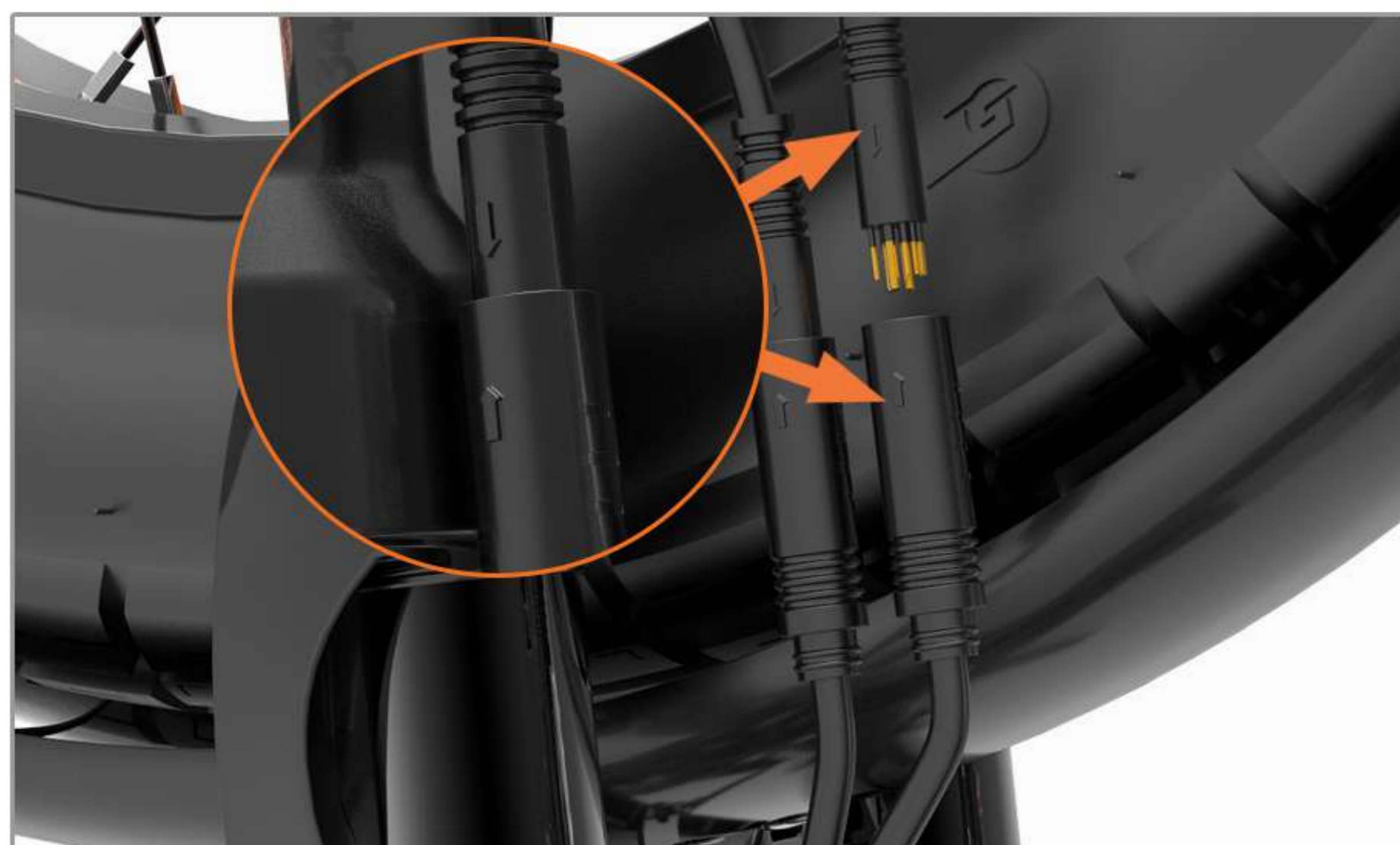

10

Connect the front wheel motor cable plug
***Pay attention to the alignment of arrows between lines when linking**



11

Fix the line on the line buckle and tighten the screw



12

Front wheel installed

PART 4: CRANK AND PEDAL INSTALLATION

**01**

Install the cover

**02**

Tighten the 3 setscrews

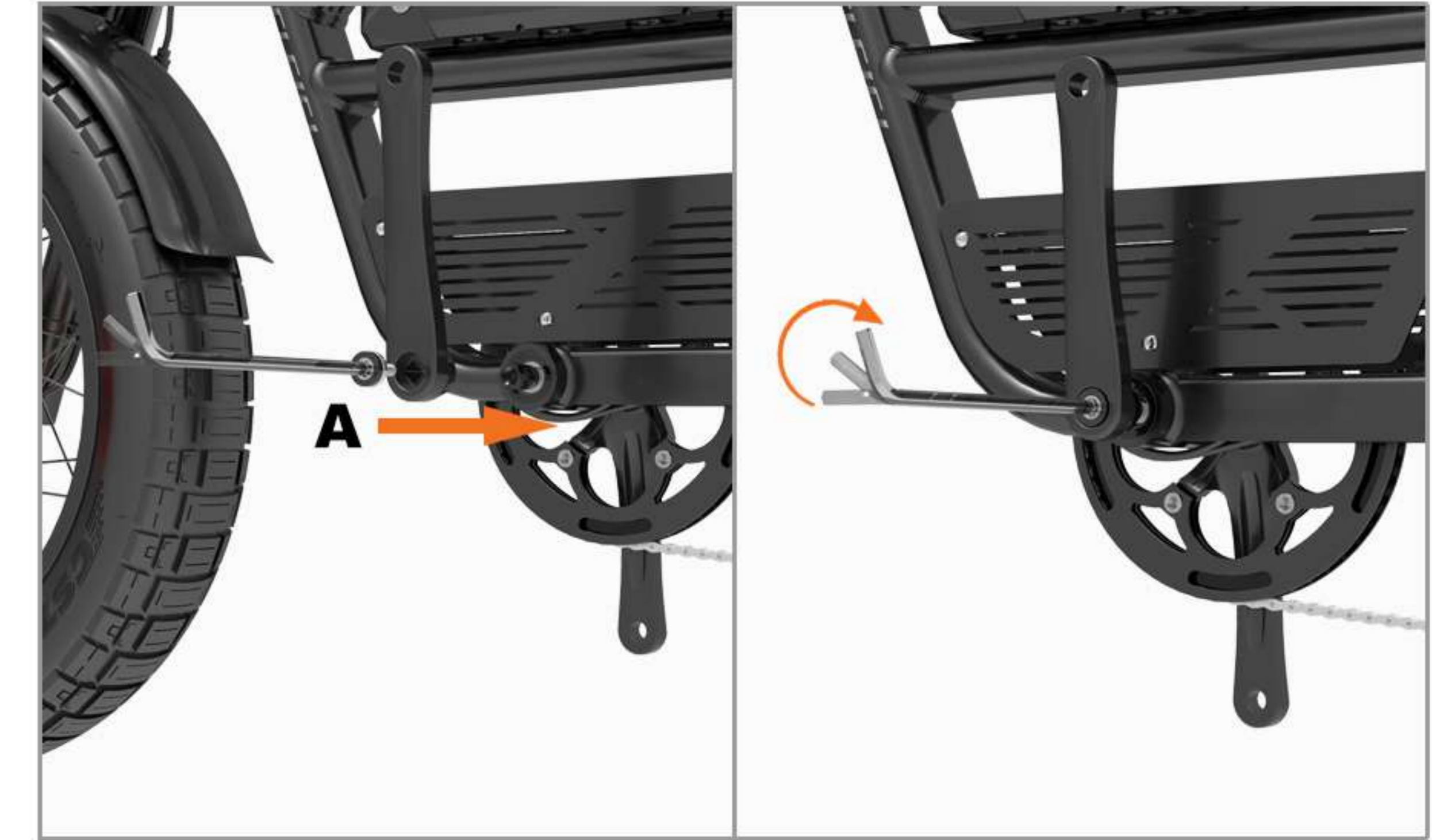
**03**

When installing the crank, note that the direction is opposite and symmetrical to the direction of the tooth plate

A: Fix with screws

**04**

Determine the left and right pedals.

"L" means the left side is mounted on the crank

"R" means the right side is mounted on the chainring

**05**

"L" pedal is fixed counterclockwise to the crank

**06**

"R" pedal is fixed clockwise and fixed on the chainring

PART 5: BATTERY INSTALLATION AND REMOVAL

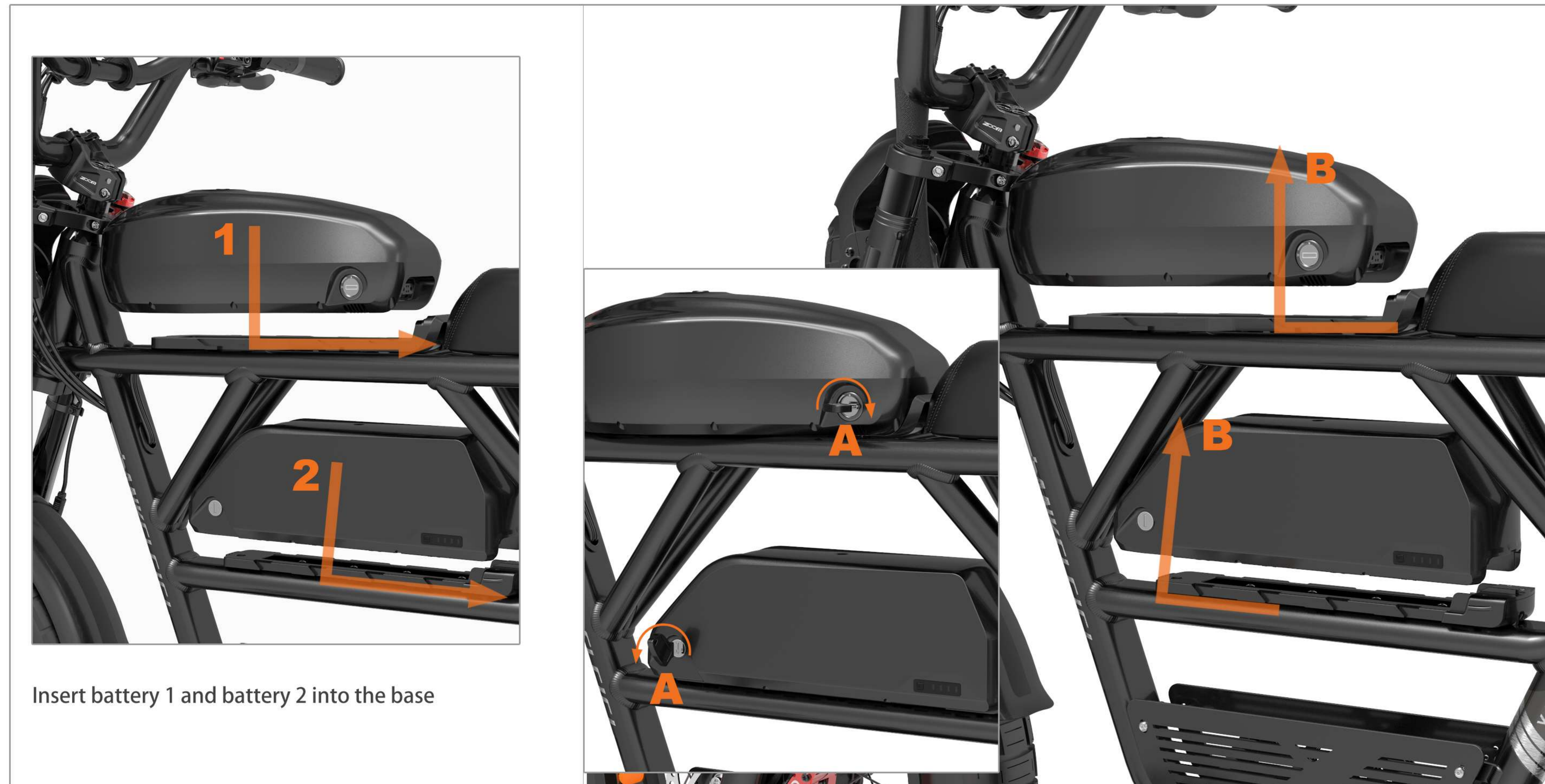

Notice

A: When unlocking, turn the key, do not release it.

B: Hold the battery with one hand and slide forward, release the button, and take out the battery with both hands.

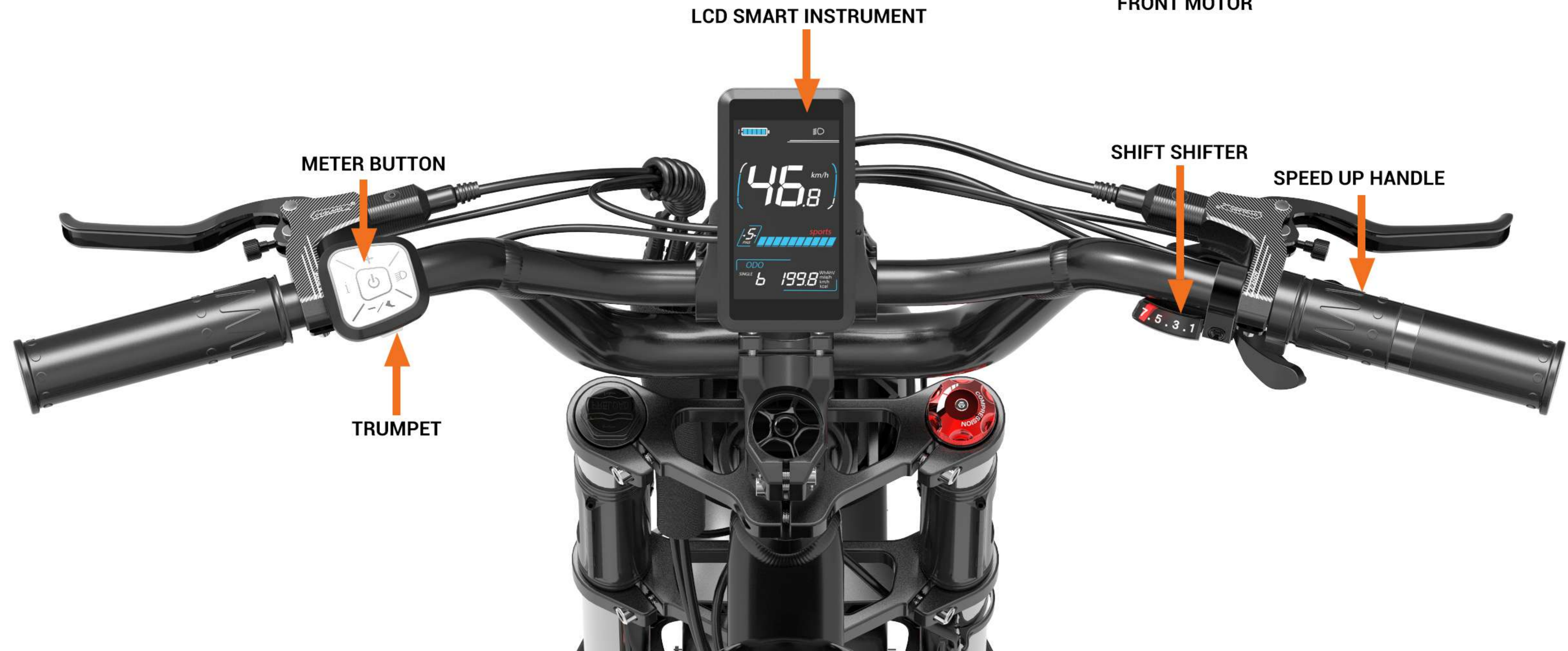
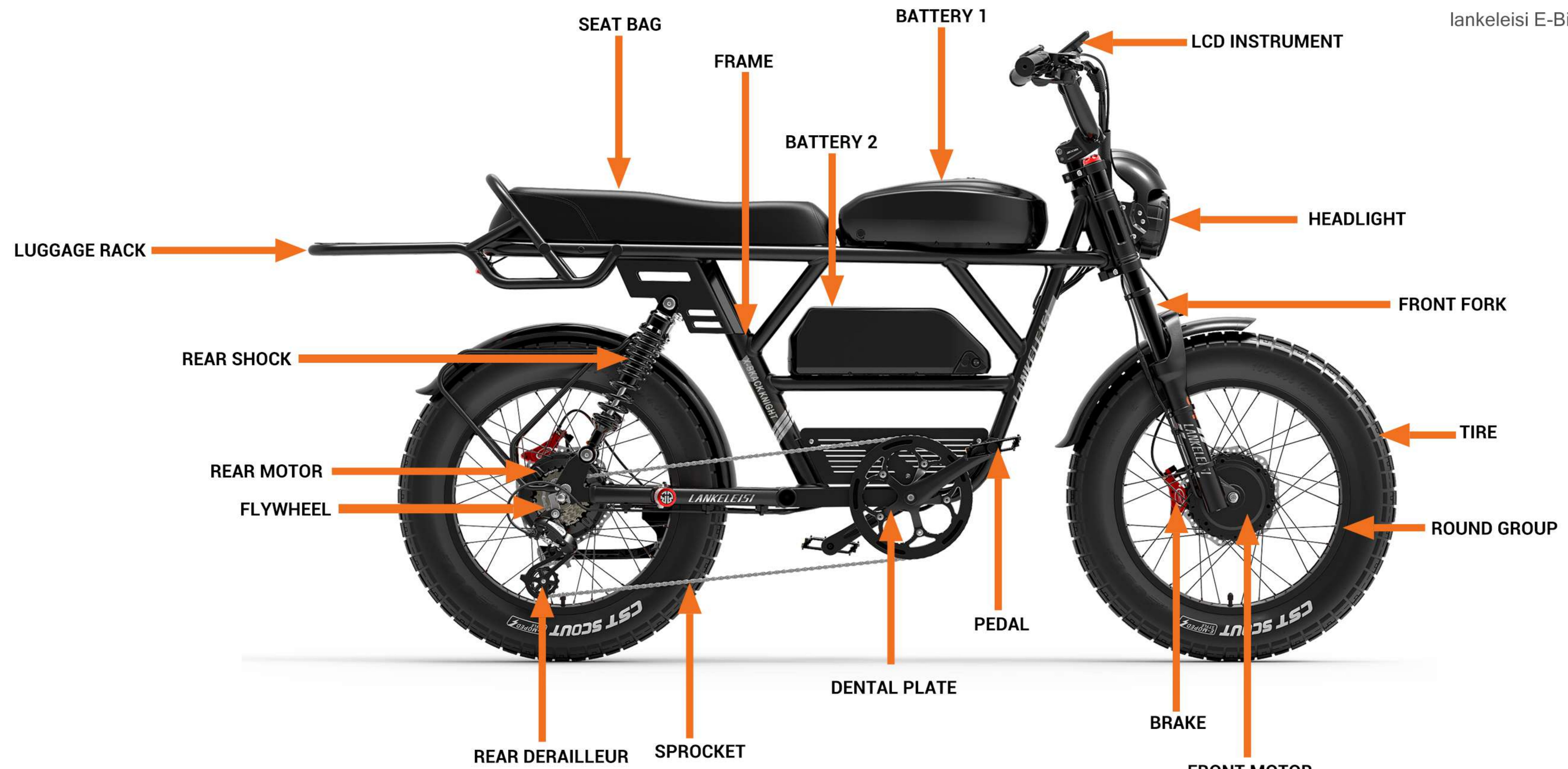

04 OPERATIONAL INSTRUCTIONS



PART 1: LCD METER FUNCTIONAL AREA DISTRIBUTION

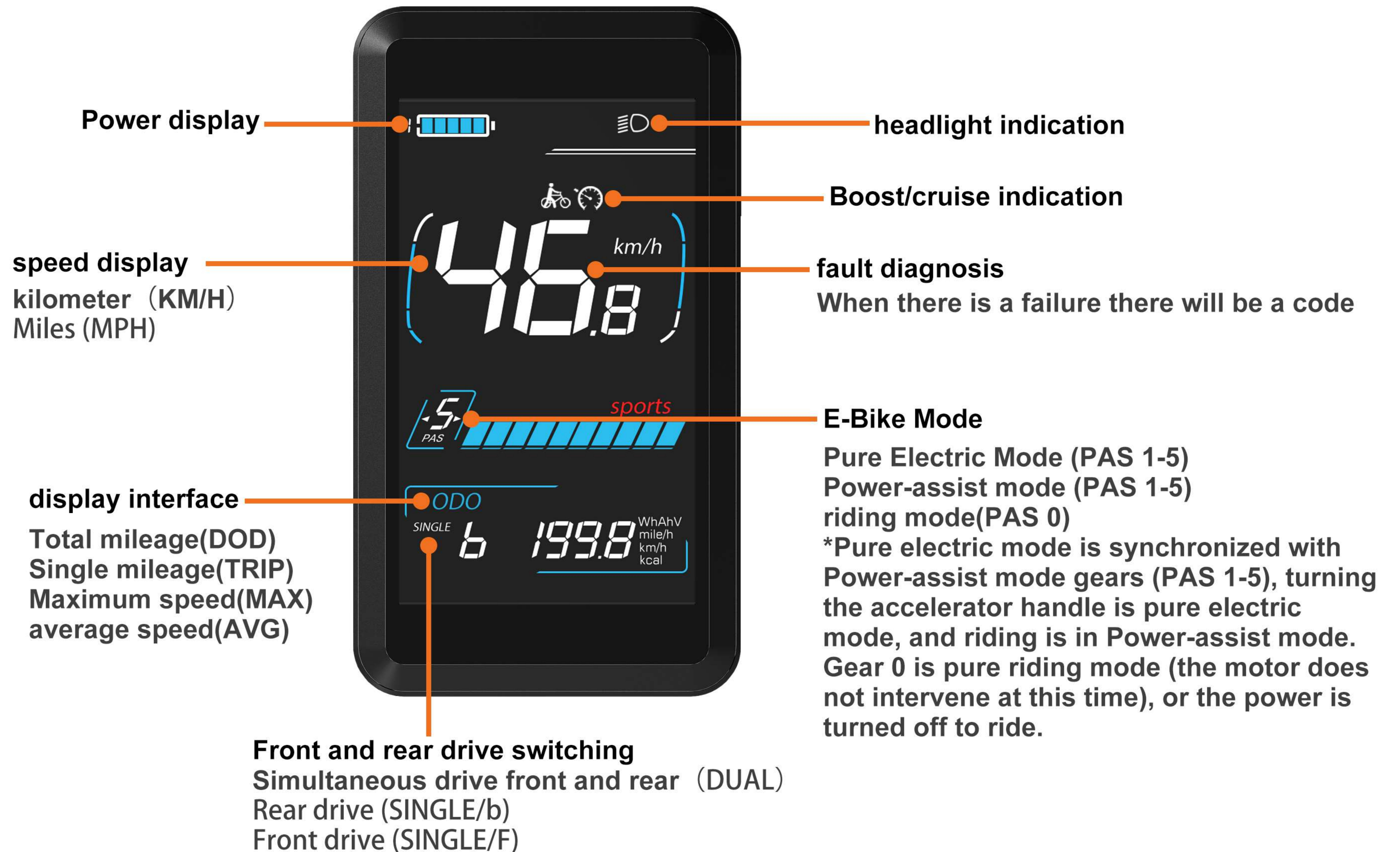





PART 2: LCD METER KEY GUIDE







The button positions and combinations are shown in the following figure:



Key operations include short press, long press, and long press key combination. Details are as follows:

1. Long press the  key to power on/off the E-bike
(*If the electric vehicle is not used for more than 10 minutes, the LCD meter will automatically shut down)
2. After power on, the LCD meter displays real-time speed (km/h) and total mileage (DOD) by default. Short press the  key to display the information to switch between total mileage (DOD), single mileage (TRIP), maximum speed (MAX), and average speed (AVG).
3. Short press the  key or the  key to switch the power level (PAS). The proportional output is shown in the following table:

PAS	0	1	2	3	4	5
output	0%	50%	61%	73%	85%	96%

4. Horn button 
5. Press the  button to turn on the headlights, Pressing off again, the LCD instrument backlight dims when the headlights are turned on, and returns to brightness when the headlights are turned off.
6. Press and hold the  button, the electric bicycle enters the electric assist push mode. Electric bikes will travel at an average speed of 6 kilometers per hour. At the same time, the screen displays . Press and hold the  key again or press the brake to cancel this mode.
(*The push function is recommended to be used when pushing the bike uphill. Do not use this function while riding.)
7. Cruise mode: When using pure electric power, reach the speed you are satisfied with, long press the  button to enter the battery life mode. Press and hold the  key again or press the brake to cancel this mode.
(*It is recommended to use this mode when the road surface is flat and there are few people.)

8. When the electric control system of the electric bicycle fails, the instrument will automatically display the error code. The detailed error code definition is shown in the following table:

ERR0R 001	controller malfunction	ERR0R 004	Turning handle failure
ERR0R 002	circuit malfunction	ERR0R 005	brake lever Fault
ERR0R 003	Hall fault	ERR0R 006	Motor phase loss

 When there is an error code on the display page, please contact the dealer in time to help you troubleshoot, the electric bicycle will not be able to run normally when there is a fault.

PART 3: PARAMETER SETTING

1. Personalized parameter setting steps:

Note: In the power-on state, the operation is performed when the display speed of the instrument is 0

Press and hold the **+** **-/↶** button for more than 2 seconds at the same time to enter the personalized parameter setting item selection interface;

Short press the **+** **-/↶** key to switch the selection interface of the personalized parameter setting item, short press the **i** key to enter the state of changing parameters;

Short press **+** **-/↶** key to select parameters, long press **+** for continuous addition Operation, long press **-/↶** for continuous reduction operation;

Short press the **i** key to save the parameter settings and return to the personalized parameter setting item selection interface;

Press and hold the **i** key to save the parameter settings and exit the personalized parameter setting option interface.

2. Parameter settings

- 01P sets options for metric and imperial units, 00 for metric and 01 for imperial.

Short press the **i** key to enter the state of changing parameters, short press the **+** or **-/↶** key to select parameters, short press **i** key, save the parameter setting and return to the personalized parameter setting item selection interface;

(01P is shown in the picture)
Metric and Imperial unit setting interface

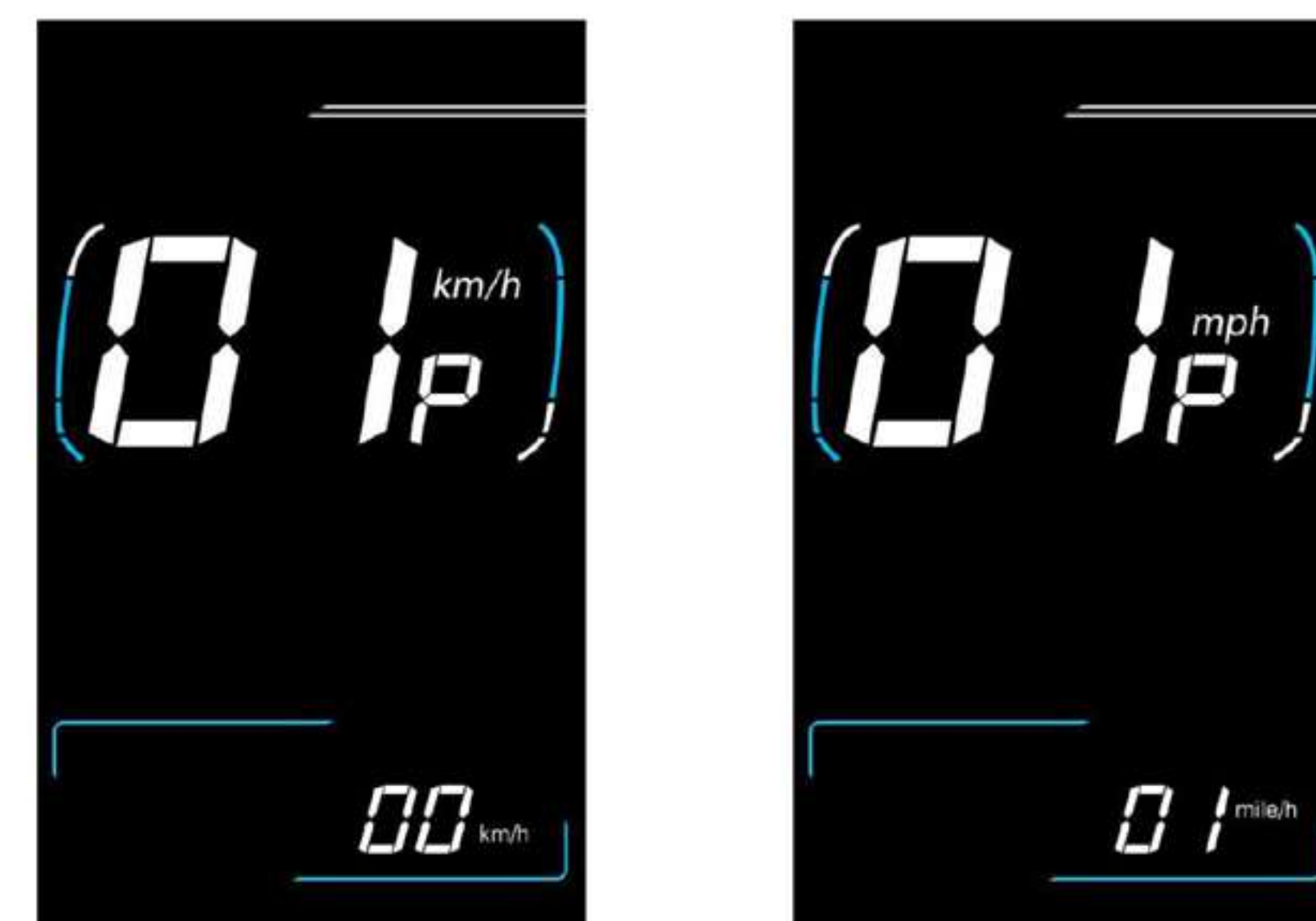

- *02P is the wheel diameter setting option, the meter can adjust the wheel diameter range: 1-50inch.

- 03P is the speed limit setting option, and the adjustable range of the instrument speed limit is: 1~100km/h.

Short press the **i** key to enter the state of changing parameters, short press the **+** or **-/↶** key to select parameters, short press **i** key, save the parameter setting and return to the personalized parameter setting item selection interface;

Adjust the parameter to 50 to remove the speed limit by default

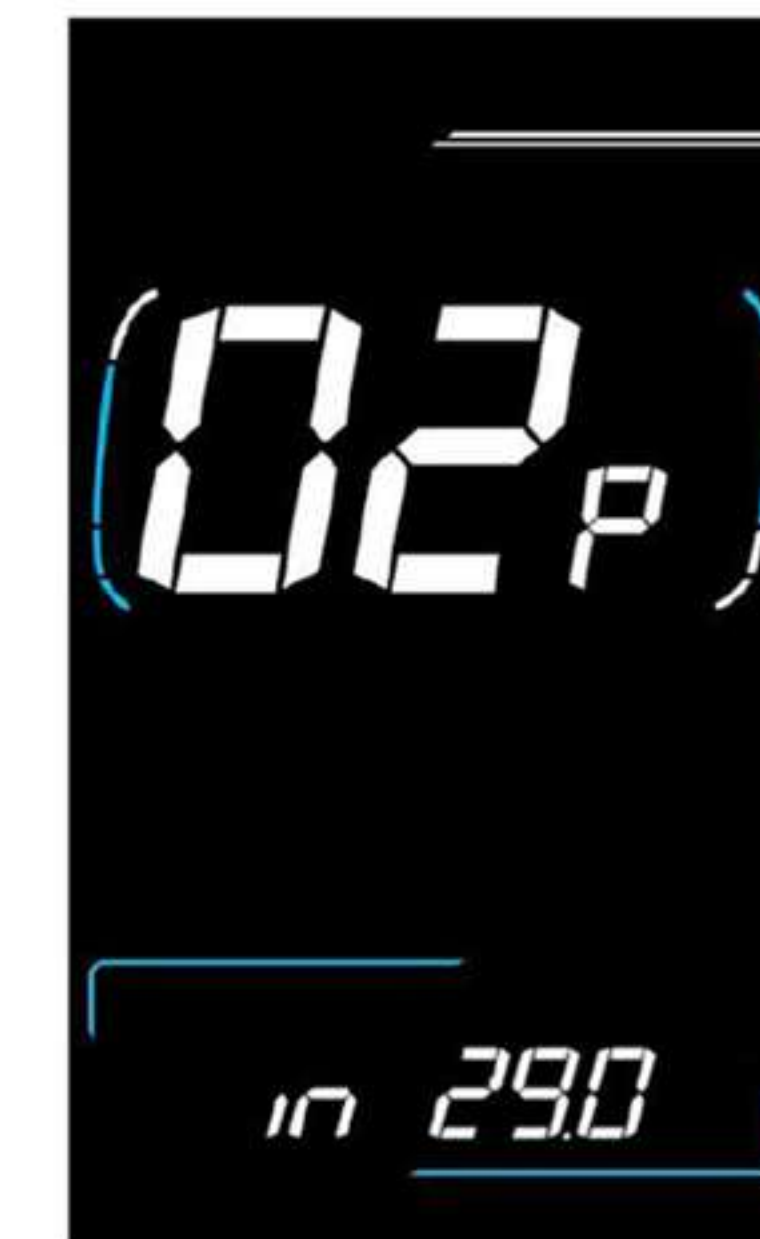

(02P is shown in the picture)

Wheel diameter setting interface



(03P is shown in the picture)

Speed limit setting interface

- *04P set options for startup method, 00→zero start, 01→non-zero start

- *05P set options for drive mode, 00→Power-assisted drive only, 01→Electric drive only, 02→Power-assisted drive and electric drive coexist.

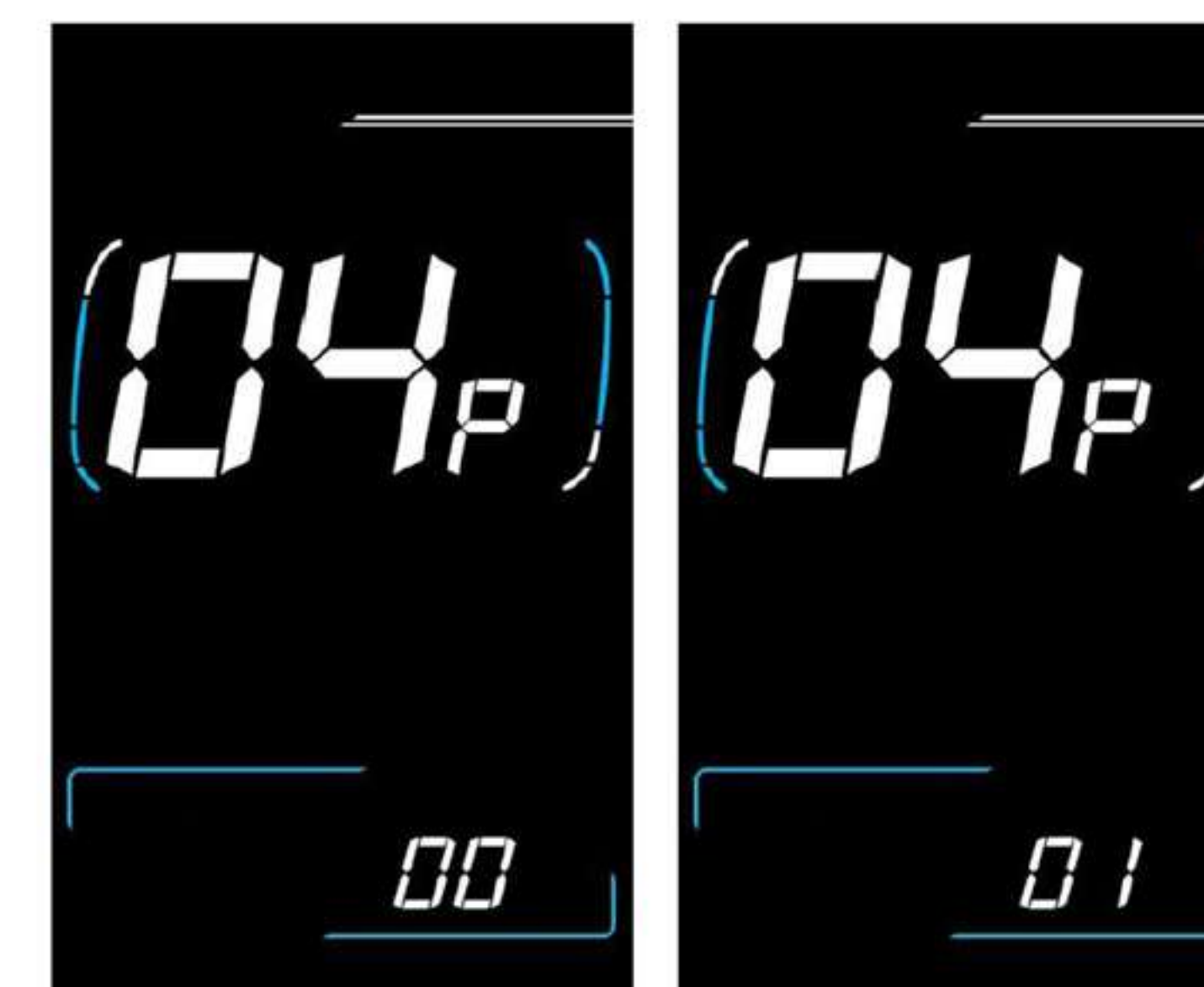

The left picture is the 04P startup mode setting interface

The right side is the 05P drive mode setting interface



⚠ The above parameters marked with * are the default parameters of the meter, please do not adjust them. If you accidentally adjust the parameters, the electric bicycle cannot work normally, please contact the dealer for help.

PART 3: PARAMETER SETTING (SHORTCUT OPERATION)

- *06P is the power-assist starting strength setting option, and the power-assist starting strength is the relative strength of the PWM signal output by the controller when the power-assisting starts. The adjustable range is 0 ~ 5, 0 is the weakest and 5 is the strongest.

- *07P sets options for controller current limiting

- PE is the power-on password setting option, the instrument power-on password function is generally not enabled by default, and the user can enable the instrument power-on password by setting PSd-y. The factory default password of the instrument is 1212. You can set a four-digit password by yourself, please remember the password after changing the password, otherwise you will not be able to use the meter.

Short press the **i** key to enter the state of changing parameters, short press the **+** or **-/↶** key to select the parameters, and select PSd-y means open Power-on password, PSd-n means to turn off the power-on password, short press the **i** key to confirm the mode and enter the four-digit power-on password setting state or exit to the personalized setting selection interface.

In the password setting state, the adjustable digits will flash, short press **+** or **-/↶** key to select the number, short press **i** key to save the number and enter the next number setting, after setting the four digits in turn, you can long press the **i** key to save and return to the personality Parameter setting item selection interface;

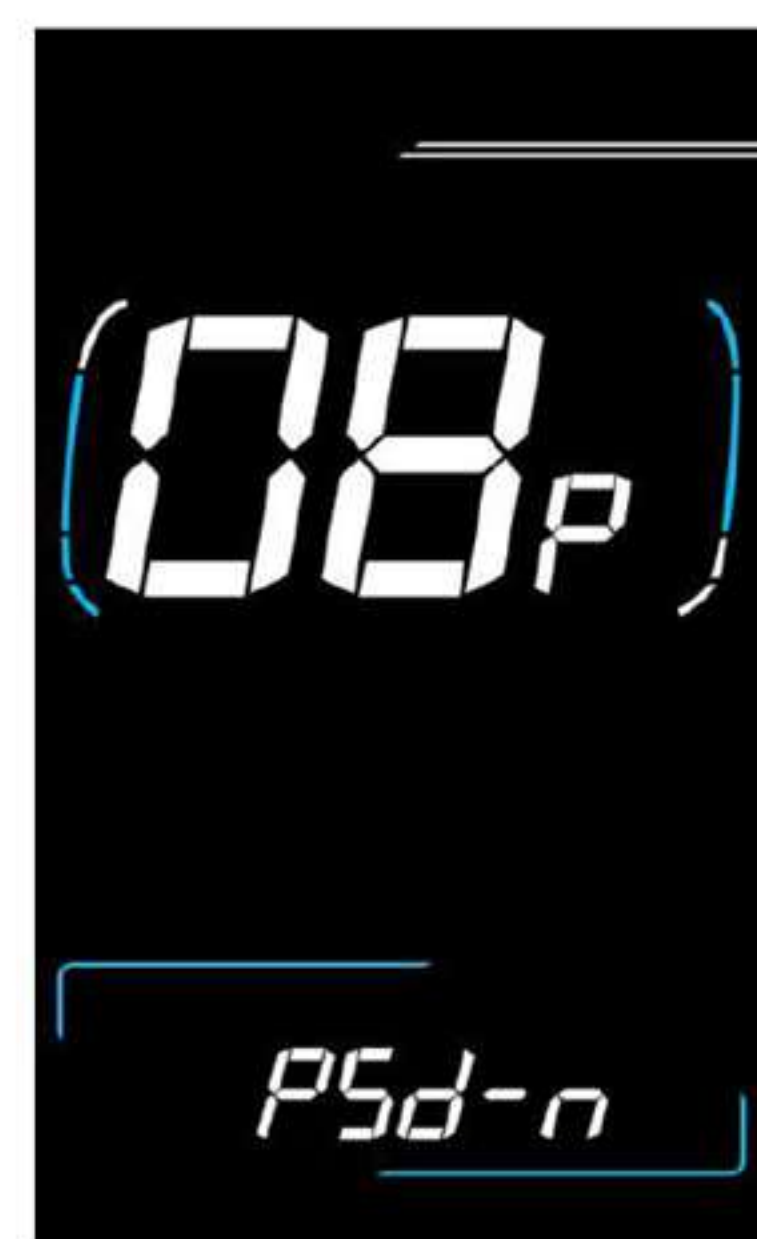

The picture shows that the power-on password is not enabled

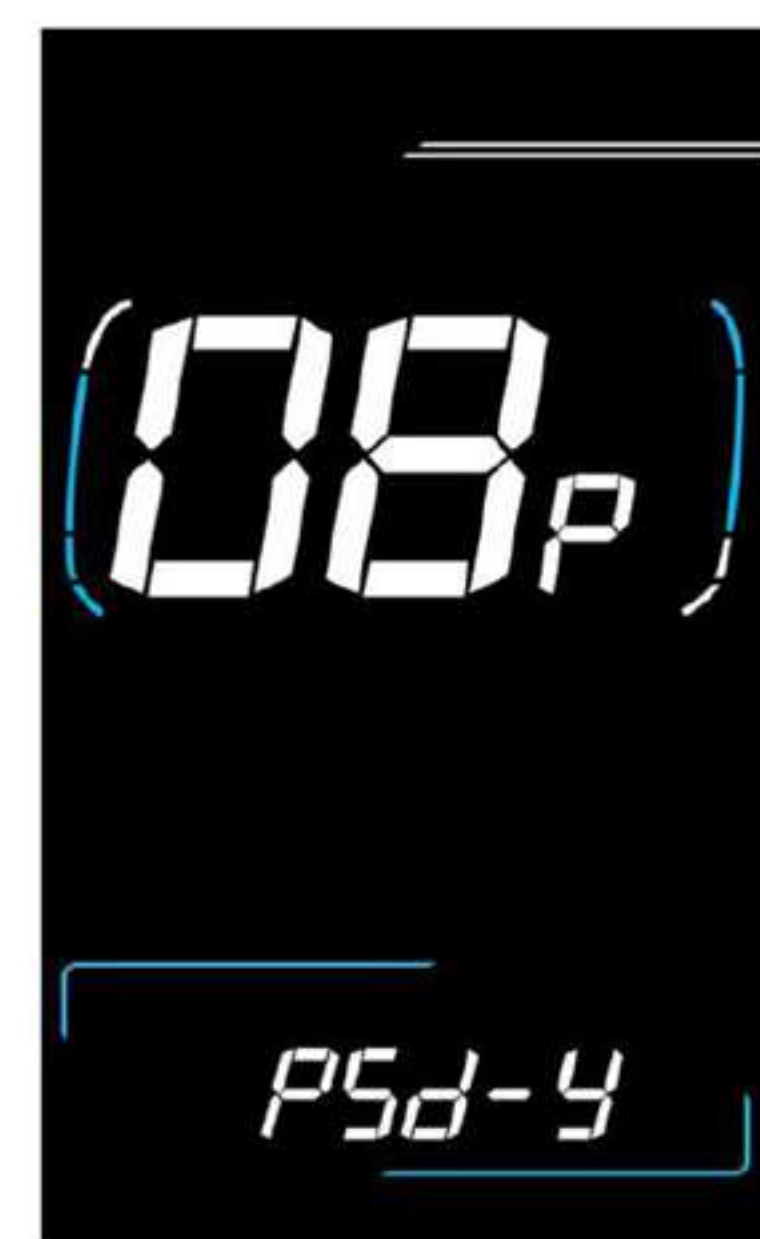

The picture shows enabling the power-on password

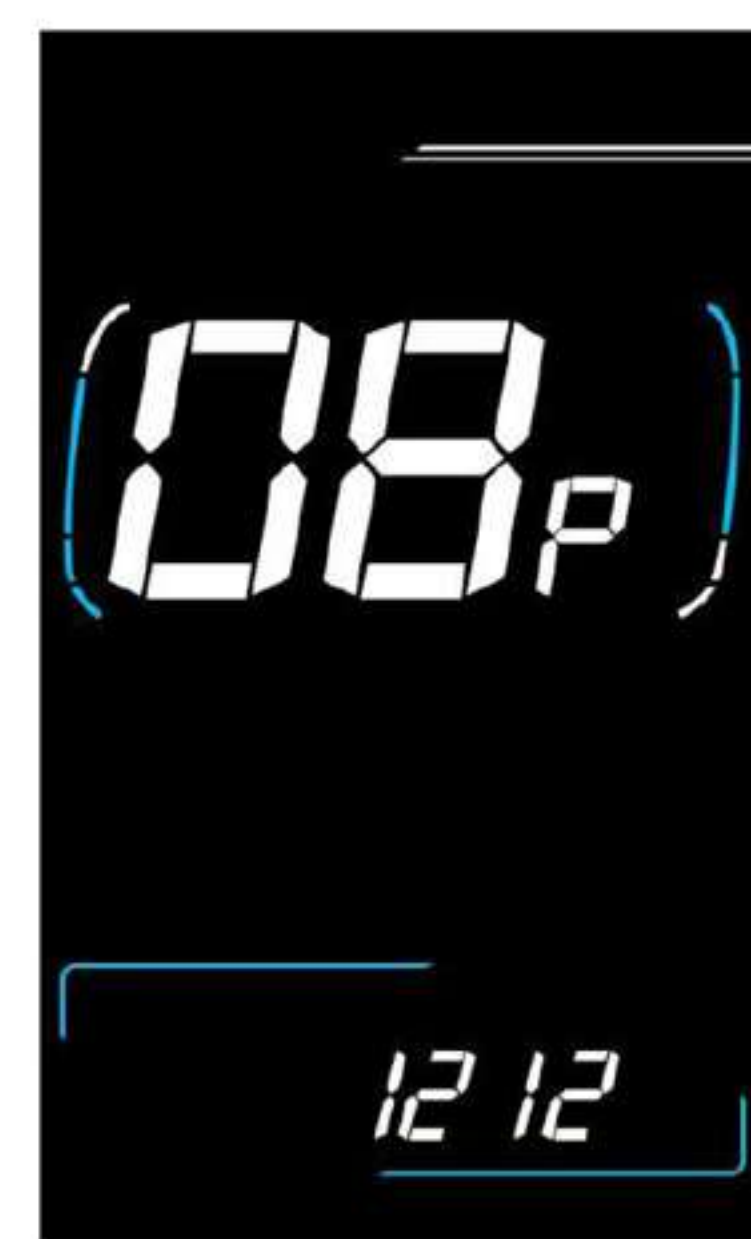

The picture shows the power-on password setting

- Dual-drive quick switching operation.

Press and hold the **+** key to quickly switch the motor drive mode to achieve different drive mode experience, SINGLE-F→single front drive mode, SINGLE-b→single rear drive mode, DUAL→dual drive mode.



Front Drive



Rear drive



front and rear drive

- dEF is the option to restore the factory default parameters, dEF-Y means that the default parameters need to be restored, and dEF-N means that the default parameters do not need to be restored. Under the condition that the speed of the main interface is 0, press the **≡** and **+** keys at the same time for more than 2 seconds to enter the restore factory default parameter interface. Short press **+** or **-/↶** key to switch, if Y is selected, short press **i** key After confirmation, the meter will display dEF-0 for a period of time and automatically start to restore the factory default settings. After the restoration of the default settings, it will automatically exit and return to the normal display interface.

- The meter can record the single mileage and total mileage. The single mileage will not be reset automatically after the meter is turned off. If you want to clear the single mileage, you need to reset it manually. The total meter mileage does not support clearing. The single mileage reset operation is as follows: Under the condition that the speed of the main interface is 0, press and hold the **-/↶** and **i** buttons at the same time for more than 2 seconds to perform a single mileage reset. During the reset process, the main interface will Blink once.

05 RECHARGING THE BATTERY



A. Remove battery from the E-Bike and recharge separately

OR



B. Remove battery from the E-Bike and recharge separately

RECHARGING THE BATTERY



ATTENTION

Connect the battery first, then connect the power supply and make sure the red LED of the charger is lit. The charger will charge the completed battery within 3 to 7 hours.

A red light indicates that the battery is charging. A green light indicates that the battery is fully charged.

06 BATTERY & CHARGER CARE

If the battery will not be used for an extended period of time, charge it fully and recharge it every 1 months.

Store in a cool, dry place. Recharge the battery before it becomes completely discharged.

Do not use it to power other electrical devices. Improper use of the battery will damage the battery and shorten its useful life and may cause fire or an explosion. If you experience unusual sounds or odors coming from the charger or the battery, unplug charger immediately and contact lankeleisi customer service

Recharge battery after every use.

Do not disassemble or alter the battery or battery charger. Do not place the battery near fire or corrosive substances. Do not allow any liquids on or inside the battery/charger. Do not expose the battery/charger to extreme weather conditions.

Do not operate the battery/charger if damaged. Recharge the battery only with a charger specified by the manufacturer.

Do not use the battery/charger for any use other than its intended purpose.

07 GEARS

Your lankeleisi E-Bike is equipped with multiple speeds. The first gear is for easier and uphill pedaling, and the last gear is for maximum speed on level or downhill terrain. Change gears only while pedaling.

The rear wheel contains seven or nine chain sprockets (depending on model). When the chain is around the largest sprocket, you are in 1st gear, or the lowest gear. The high gear will have the derailleur positioned so that the chain is directed around the smallest gear. Every

position on the gear selector should cause a gear change. Adjustments require fine tuning and should only be made by a qualified technician.

Avoid changing gears very rapidly from first gear to the last gear or vice versa. If you change multiple gears too quickly, you could cause the chain to come off the sprocket.

08 LED DISPLAY

RIDING MODES

Power Assist System coexists with pure electric mode (PAS)

PAS 0: pure riding mode (no power)

PAS 1: Low speed level, 5-16KM/H

PAS 2: Medium speed level, 16-22KM/H

PAS 3: High speed level, 22-28KM/H

PAS 4: Very high speed level, 28-34KM/H

PAS 5: Maximum speed level, 34-41KM/H

To ride in full electric mode (no pedaling), set your LED display to PAS 1-5. In this mode, your speed can be changed by twisting the throttle. You can also use your foot pedal, at which point the power assist system steps in

The speeds listed here are only for reference. Actual speeds will be affected by rider weight, temperature, road situations, incline, battery status, etc.



09 KEYS

Your LANKELEISI e-bike comes with a key:

- The key to the battery holder on the bicycle frame

WARNING

Keep out of reach of children. Always keep your keys in a safe place to avoid losing them.

10 BRAKES

It's important to your safety that you instinctively know which brake lever controls which brake. On your lankeleisi E-Bike, the right brake lever controls the front brake. The left brake lever controls the rear brake.

Your lankeleisi E-Bike is equipped with disc brakes for maximum reliability. Applying hand pressure to the brake levers will cause the wheel brake to create friction against the brake disc, slowing the wheel. The more hand pressure applied to the brake lever, the faster the E-Bike will come to a stop.

The rear brake should always be applied before and while the front brake is applied. Applying only the front brake to slow or stop at high speeds may result in the rider being ejected from the saddle and continuing forward over the handlebars. It is best to apply even pressure to both brake levers when slowing or stopping.

Bicycles equipped with disc brakes will occasionally make a slight scraping noise when the wheels are turning without the brakes being applied. This is normal.

Make sure that the brake lever does not contact the handle bar when full hand pressure is applied (Figure 1). Brake normal state (Figure 2). A quick adjustment may be made by screwing or unscrewing the threaded barrel adjuster on the brake lever until the brakes are fine-tuned for safe, just adjust it close to Figure 1.

If the brakes are still not operating correctly, they may require further adjustment by an experienced bicycle mechanic.

WARNING

- Disc brake rotors become hot during use. Do not touch or come in contact with the disc rotor shortly after use.
- Wet weather will require a longer distance to stop. Brake earlier and avoid sudden stops when riding in wet conditions.



FIGURE 1



FIGURE 2

11 TIRES & INNER TUBES

Tires should not be deflated unless necessary. To minimize tire wear and for maximum riding safety, comfort, and handling, maintain recommended tire air pressure. This can be found on the side wall of all tires. Use a reliable

tire air pressure gauge to check for proper inflation before every ride. At the same time, inspect tires for excessive wear and cracks. Replace tires if necessary.

12 APPEARANCE

Periodically clean your lankeleisi E-Bike with a damp cloth. Avoid spraying the lankeleisi with a water hose to avoid electrical issues. Store your lankeleisi in a dry, sheltered area away from direct sunlight and wet or damp environments.

It is also recommended to apply chain lube (such as Tri-Flow or ProLink) to the drivetrain of your E-Bike when you clean it up or wipe it down to keep it in good running condition.

13 TROUBLESHOOTING

If your lankeleisi E-Bike is not working, check the Quick Disconnect fittings to make sure they did not come loose or unplug

Simply unwrap the black spiral wire covering until the Quick Disconnect fitting is exposed, unplug and re- plug the Quick Disconnect fitting(s).



14

LANKELEISI E-BIKES FAQ

Q. How long does it take to fully charge the battery?

A. It depends on the state of depletion, but around 3-6 hours if completely discharged.

Q. Can I ride up hills and against strong headwinds on my lankeleisi electric bike?

A. Yes. One of the main advantages of cycling on a lankeleisi electric bicycle is that it flattens hills and increases your average speed when tackling inclines and headwinds. If you provide a reasonable amount of effort, you should be able to tackle anything from a 10% gradient up to a 14% gradient. You will be amazed at the relative ease with which your new lankeleisi electric bike can tackle some of the most arduous journeys.

Q. Do I need to pedal an electric bike?

A. No, but it helps to prolong battery life. The motor on our bikes is both throttle and pedal assist controlled, allowing you to decide how much power you desire. Have you ever tried to cycle when speeding downhill on your normal bicycle? It's just like that. The motor is propelling you faster than you're cycling, so there is pretty much no resistance. It's merely a formality!



Q. What happens when I use the brakes under powered assistance?

A. All of our bikes are equipped with brake levers that have a built-in safety switch that automatically cuts off the motor power under normal braking conditions. This not only ensures a safe unpowered stopping feature, but also protects the motor under braking conditions so that it isn't working against the brakes.

Q. How far will a lankeleisi take me?

A. This all depends on a few factors. Cycling with pedal assist along a straight road under normal conditions, the standard battery should last about 35-50 km. Cycling up steep hills will obviously take more energy out of the battery and factors such as road surface, wind resistance, weight of the rider, and tire pressure will affect your range.

Q. What happens if I get a flat tire?

A. The tires on our bikes are the same as conventional bicycles. Simply replace the tube with a tube of the right size and inflate it. No special tires or parts will be needed.

Q. How do I know when the battery is low?

A. A clearly visible indicator on the LED screen shows the amount of juice remaining. If it's getting lower and lower and you don't think you can get to your destination, you can turn off the motor and reserve it for the hard part.

Q. Do I have to wait for the battery to empty before I charge it?

A. No. The batteries we use are Lithium-ion batteries which do not suffer from 'memory effect.' This means that there is no need to discharge a battery completely before you recharge it again. You can partially recharge the battery at any time without reducing its voltage or lifespan. We recommend recharging the battery after every use, regardless of how far you rode.



15

INSPECTION & MAINTENANCE



Hand brake cut-off power

When your bike is equipped with brake cut-off power set, the bike will automatically cut off power when the brake is used.

Low voltage protection

When the battery output voltage reaches its limit, the electronic control system will cut off the power to automatically protect the battery. When the battery reaches its minimum voltage, you can switch to pedal riding. The battery should be recharged before riding again.

Power off

When your E-Bike is not in use, please turn off the power.

Charge indicator

Red indicates charging, green indicates that the battery is full.

Note: The battery switch must be turned off using the switch on the bottom when the battery is charging. The battery must be fully charged before the first use. We recommend you charge the battery for a full 6 hours after your first 3 uses. If the bike is not used for a long time, you should fully charge and remove the battery. While not in use, keep the battery turned off and recharge every 2 months.

Make sure to keep the battery and charger away from children during charging.

Do not attempt to disassemble or modify the battery or charger.

Do not use the battery or charger for any use other than its intended purpose.

Battery charging

Plug in the connector between the charger and the battery, then plug the charger into an electrical outlet. The LED indicator on the charger will show red, which means charging. When the indicator light turns green, the battery is fully charged. When you are finished charging, first unplug the charger from the power supply, and then unplug the connector between the battery and the charger.

During the charging process, the charger and battery should be placed in a stable and cool place. The battery operating temperature range should be between 32 and 110 degrees Fahrenheit. Do not put any cover on the battery or charger. Make sure that no liquid comes into contact with the charger.

Mileage

Performance of electric bicycles is affected by road conditions, rider/load weight, and weather conditions. We recommend that you manually pedal as often as possible to improve your travel distance and battery life.

Inclines

When riding uphill on an incline of 15 degrees or more, we recommend using the pedal to assist your climb.

Cleaning

When cleaning your electric bicycle, wipe with a dry or damp cloth, do not spray directly with a hose. Do not put oil on the front brake.

The seat tube should be cleaned and lubricated if necessary.

Parking

Please make sure your lankeleisi E-Bike is parked in a stable place and the kickstand is used.

BASIC MAINTENANCE

1. To ensure that your E-Bike is in the best condition, maintain and clean regularly.

2. Regularly check that the tires are inflated correctly.

3. Make sure that quick release, nuts and bolts are tightened.

4. After a period of riding, check that the spoke tension is normal. Adjust as needed.

5. The frame and other parts are made of aluminum alloy. Avoid friction or collision and clean it regularly.

6. Do not take apart the motor, battery, or controller yourself. If necessary, take your E-Bike to a professional bicycle technician for repairs.

7. Do not use high-pressure water to clean your E-Bike. Keep water away from the controller, battery and motor.

8. Lubricate the chain, flywheel, head parts, kickstand, etc. when necessary.

16

WARRANTY CERTIFICATE

Important

LANKELEISI warranties against manufacturer defects for all of our regular electric bikes and parts except accessories.

The warranty period begins on the delivery date within twelve (12) months.

Please note this warranty only covers the initial purchaser and DOES NOT cover accessories.

Validity

The warranty is valid only when:

- a)The Product is purchased from LANKELEISI authorized dealers or outlets.
- b)The Product is NOT transferable to any third party either in ownership or during the period of contract.
- c)The model and serial label should not be defaced or removed from the Product.

Exclusion

The warranty is not applicable to:

- a)Damage or loss caused by modification, alteration, or repair by any unauthorized party.
- b)Damage or loss cause by mishandling by the customer or person(s) with access to the product on the customer's premises.
- c)Normal wear and tear.
- d)Damage or loss caused by Acts of God or any other causes beyond LANKELEISI's control.

e)Damage or loss as a result of external bodies.

f) Damage or loss caused by another device that is connected to the Product.

g)Damage resulting from accidents, misuse, abuse, tampering, or failure of the customer to follow normal operating procedures outlined in the user manual.

h)General maintenance and servicing.

lankeleisi E-Bike Warranty

In the rare case that your E-Bike arrives and does not work, the next course of action is repair or replacement AT MANUFACTURER'S DECISION. In order to honor the warranty the following must be followed:

- If your E-Bike is received with a defect, lankeleisi will take care of the shipping fees (at lankeleisi's instruction) and immediately ship replacement equipment or repair the equipment.
- If your E-Bike is in need of repairs, the owner must contact lankeleisi and will receive a Return Authorization (RA) Number and all of the necessary information.lankeleisi will not accept returns without an RA.
- All returns must be properly packaged to prevent damage during shipment. An explanation of the problem or damage and a proof of purchase must be submitted with the return which will be shipped by the owner.
- The RA number must be clearly visible.
- The owner will be responsible for insurance of the merchandise (at owner's cost) because lankeleisi will not be responsible for damages or losses during shipment.

The warranty is void if: The damages are a result of an accident, abuse, alteration, non-authorized usage, or use of electricity other than that indicated in this manual.

The warranty is void if: The owner or user neglected to do routine maintenance required and the damages or problems are directly related to such neglect. It is the user's responsibility to keep the E-Bike in proper condition.

Certain parts of the equipment are not covered by the lankeleisi warranty due to the fact that they require replacement after multiple uses. For example: buttons, pedals, seats, tires, etc. These parts will eventually require replacement at the owner's cost.

The manufacturers will not be held responsible for damages or monetary losses related to the purchase or use of their products. Tailwind denies responsibility for all physical and moral damages linked to the purchase and use of their products. In all cases, the damages cannot exceed the purchase price paid by the initial owner.

The final decision to honor the warranty is taken by lankeleisi personnel after a technical inspection when the owner returns defective products.

The warranty excludes:

1. Replacement and shipping costs of products worn out by normal use.
2. Replacement and shipping costs of products due to problems related to neglect, abuse, or lack of maintenance.

Warranties are NON-TRANSFERABLE.

Product Data

E-Bike Model: _____
 Serial Number: _____
 Purchase Date: _____
 Order Number: _____

LANKELEISI

DONGGUAN JIETU OUTDOOR SPORTS GOODS CO., LTD.

ADD: NO. 1, HEDONG 2ND ROAD, JINSHA, CHANG'AN, DONGGUAN, GUANGDONG, CHINA

MAIL: MING@LKLSEBIKE.COM

 **WWW.LKLSEBIKE.COM**
